



INDAmatic

300 TO 900 MM MODELS.
4 OPTIONS OF INVISIBLE RUNNERS.
SOFT-CLOSING.

“EUROPA” drawer

COMPACT



"EUROPA" drawer compact

300 TO 900 MM MODELS. 4 OPTIONS OF INVISIBLE RUNNERS.
INDAMATIC SOFT-CLOSING SYSTEM.

		<i>pp.</i>
1	COMPONENTS	462
	■ DRAWERS	462
	<i>Stainless steel</i>	462
	<i>Plastic coated steel</i>	462
	<i>Plastic moulded</i>	463
	■ SPECIAL DRAWER SIZES	464
	■ RUNNER RANGE	465
	<i>Partial extension</i>	465
	<i>Full extension</i>	467
	■ FRONT BRACKET	468
2	ACCESSORIES	468
	■ POTS & PANS DRAWER ACCESSORIES	468
	■ CUTLERY TRAY	469
	■ PLASTIC MOULDED DRAWER SIDE COVER	469
	■ MAT	469

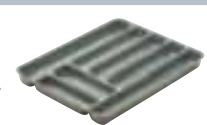

1 COMPONENTS

■ DRAWER: *Stainless steel*

STAINLESS STEEL DRAWER.

MODULE	STAINLESS STEEL	
300	684.030.104	10
350	684.035.100	
400	684.040.103	
450	684.045.106	
500	684.050.102	
600	684.060.101	



■ DRAWER: *Plastic coated steel*

PLASTIC COATED STEEL DRAWER.

MODULE	WHITE RAL 9001	GREY	WOOD MAPLE-HONEY	
300	684.130.005	684.130.311	684.130.904	10
350	684.135.001	684.135.314	684.135.900	
400	684.140.004	684.140.310	684.140.903	
450	684.145.000	684.145.313	684.145.906	
500	684.150.003	684.150.316	684.150.902	
600	684.160.002	684.160.315	684.160.901	



GREY PLASTIC COATED STEEL DRAWER “KIT-5”

MODULE	GREY	
300	684.430.316	1
350	684.435.312	
400	684.440.315	
450	684.445.311	
500	684.450.314	
600	684.460.313	

EACH BOX CONTAINS 5 DRAWERS WITH THE CORRESPONDING RUNNERS, ADJUSTABLE FRONT BRACKETS AND SCREWS.

DRAWER: Plastic moulded

PLASTIC MOULDED DRAWER.

MODULE	WHITE RAL 9001	GREY RAL 7040	
300	684.530.000	684.530.313	20
350	684.535.003	684.535.316	
400	684.540.006	684.540.312	
450	684.545.002	684.545.315	
500	684.550.005	684.550.311	
600	684.560.004	684.560.310	
900	684.590.001	684.590.314	10



KIT OF WHITE RAL 9001 PLASTIC MOULDED DRAWERS.

MODULE	4 DRAWERS KIT	5 DRAWERS KIT	
300	684.830.005	684.930.002	1
350	684.835.001	684.935.005	
400	684.840.004	684.940.001	
450	684.845.000	684.945.004	
500	684.850.003	684.950.000	
600	684.860.002	684.960.006	
900	684.890.006	684.990.003	

EACH BOX CONTAINS 4 OR 5 DRAWERS WITH THE CORRESPONDING RUNNERS, ADJUSTABLE FRONT BRACKETS AND SCREWS.

CUTLERY DRAWER.

MODULE	WHITE RAL 9001	GREY RAL 7040	
300	684.630.004	684.630.310	20
350	684.635.000	684.635.313	
400	684.640.003	684.640.316	
450	684.645.006	684.645.312	
500	684.650.002	684.650.315	
600	684.660.001	684.660.314	



CUTLERY DRAWER WITH TRAY.

MODULE	WHITE RAL 9001	GREY RAL 7040	
300	684.730.001	684.730.314	5
350	684.735.004	684.735.310	
400	684.740.000	684.740.313	
450	684.745.003	684.745.316	
500	684.750.006	684.750.312	
600	684.760.005	684.760.311	



SPECIAL DRAWER SIZES

PLASTIC MOULDED DRAWER SIDES.

LENGTH OF THE DRAWER	WHITE RAL 9001	GREY RAL 7040	
270	683.327.002	683.327.315	
400	683.340.000	683.340.313	20
480	683.348.002	683.348.315	



CALCULATION OF THE BOTTOM

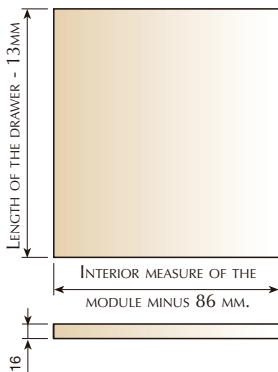

CALCULATION OF THE BACK

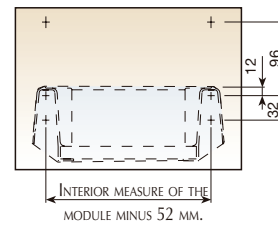
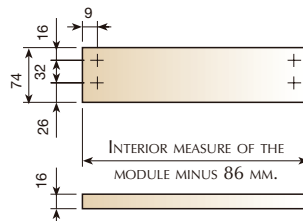

ALUMINIUM SIDES.

LENGTH OF THE DRAWER	SILVER ANODIZED	
270	683.427.511	
400	683.440.516	20
480	683.448.511	



CALCULATION OF THE BOTTOM

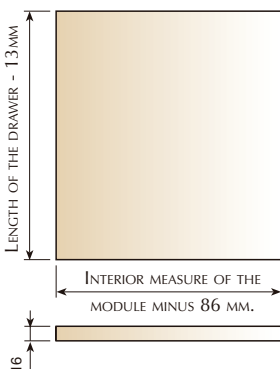

CALCULATION OF THE BACK

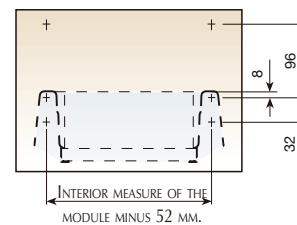
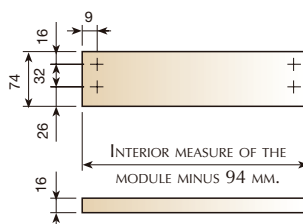

■ **RUNNER RANGE: *Partial extension***

“MARC” RUNNER WITH DROP.

LENGTH	EXTENSION	REF. SIDE	
	PS	16 MM.	
270	60	768.527.034	20
400	80	768.540.032	
480	90	768.548.034	
520	50	768.552.035	



PANEL CAVITY		
MODULE	F	LONG
300	160	408
350	210	
400	260	
450	310	
500	360	
600	460	

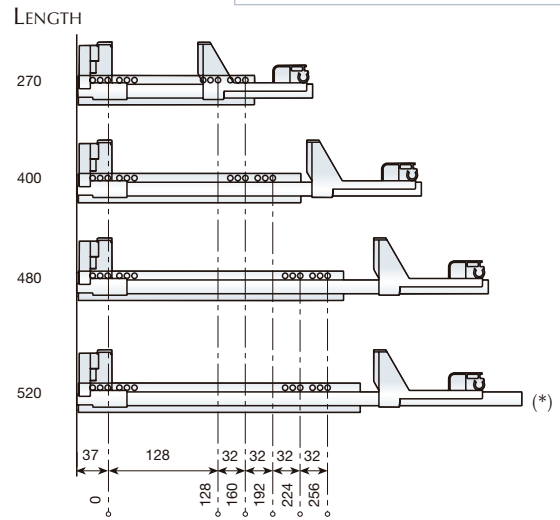
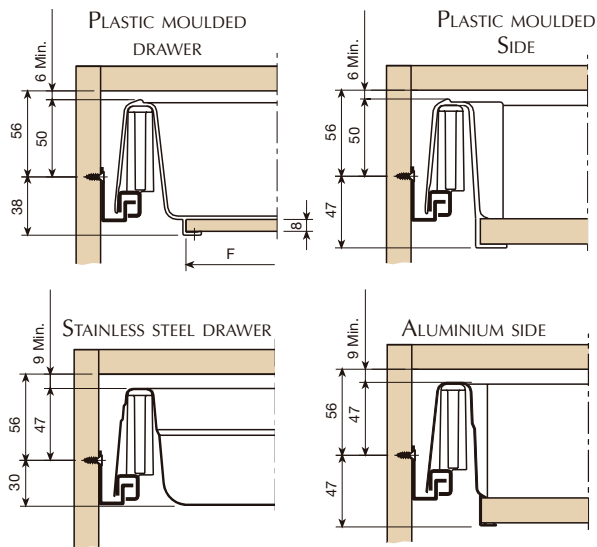

RUNNER RANGE: *Partial extension*

"MARC" RUNNER WITH SELF-CLOSING SYSTEM.

LENGTH	EXTENSION LOSS	REF. SIDE	REF. SIDE	
	PS	15÷16 MM.	18÷19 MM.	
270	55	767.127.034	768.127.032	20
400	75	767.140.032	768.140.030	
480	75	767.148.034	768.148.032	
520	FULL ACCESSIBILITY	767.152.035	768.152.033	

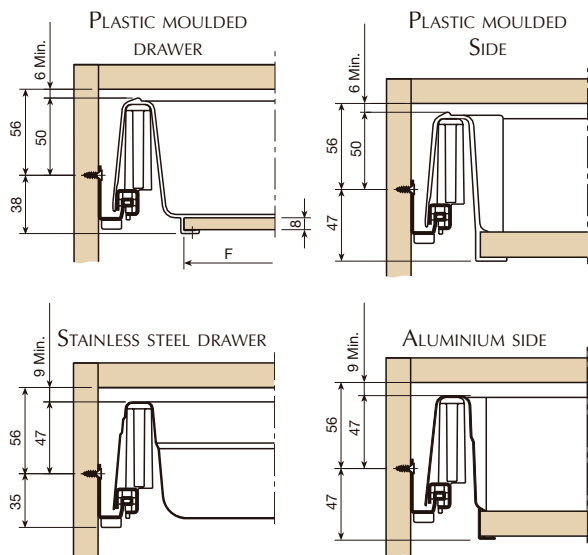

PANEL CAVITY		
MODULE	F	LONG
300	160	408
350	210	
400	260	
450	310	
500	360	
600	460	

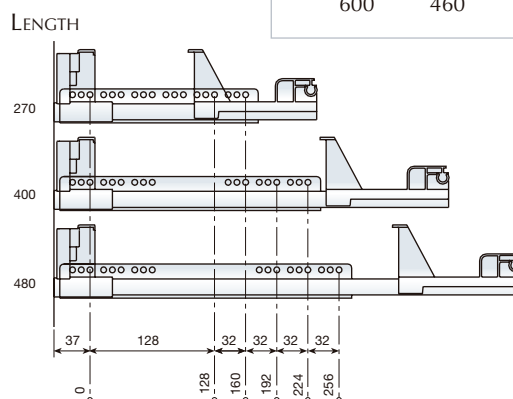

"MARC" RUNNER WITH SELF AND SOFT-CLOSING.

LENGTH	EXTENSION LOSS	REF. SIDE	
	PS	16 MM.	
270	60	768.827.032	20
400	80	768.840.030	
480	90	768.848.032	
520	50	768.852.033	

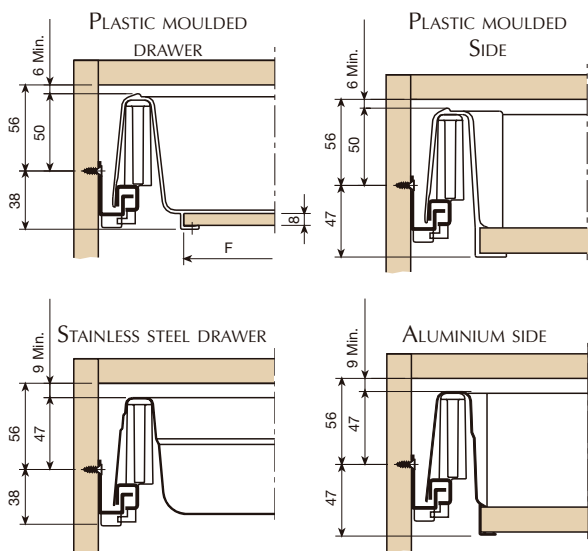

INDAmatic
gradual closing

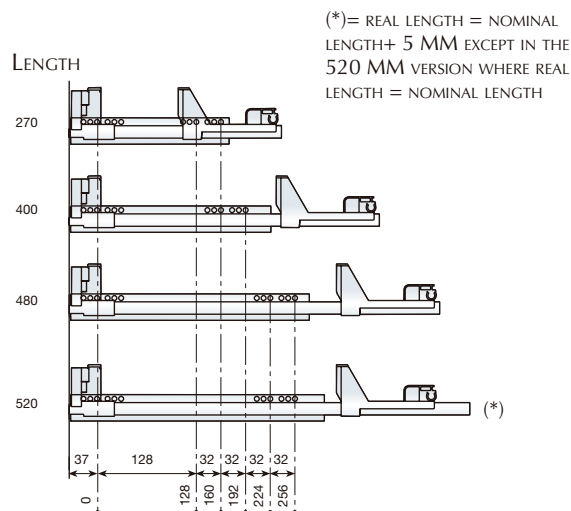

RUNNER RANGE: Full extension

TELESCOPIC "MARC" WITH SELF-CLOSING.

LENGTH	EXTENSION LOSS	REF. SIDE	REF. SIDE	
	PS	15÷16 MM.	18÷19 MM.	
270	0	767.327.035	768.327.033	10
400	0	767.340.033	768.340.031	
480	0	767.348.035	768.348.033	

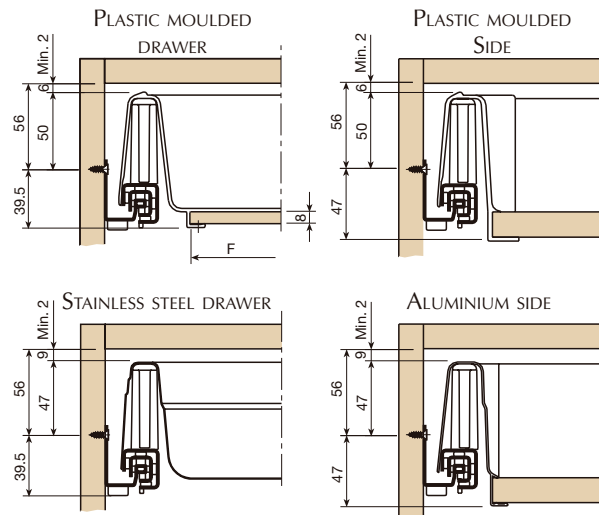

PANEL CAVITY		
MODULE	F	LONG
300	160	
350	210	
400	260	408
450	310	
500	360	
600	460	

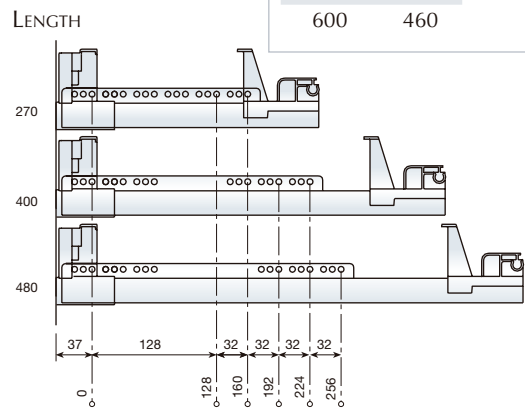

TELESCOPIC "MARC" RUNNER WITH SELF AND SOFT-CLOSING.

LENGTH	EXTENSION LOSS	REF. SIDE	REF. SIDE	
	PS	15÷16 MM.	18÷19 MM.	
270	0	767.427.032	768.427.030	10
400	0	767.440.030	768.440.035	
480	0	767.448.032	768.448.030	

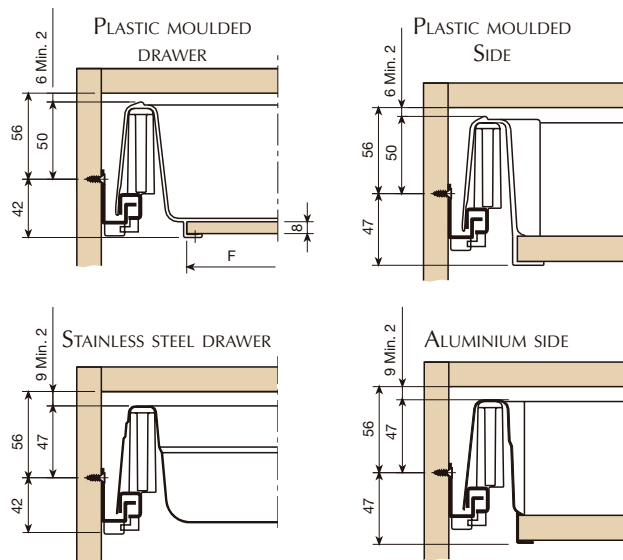

INDAmatic
gradual closing



(*) = REAL LENGTH = NOMINAL LENGTH + 5 MM EXCEPT IN THE 520 MM VERSION WHERE REAL LENGTH = NOMINAL LENGTH

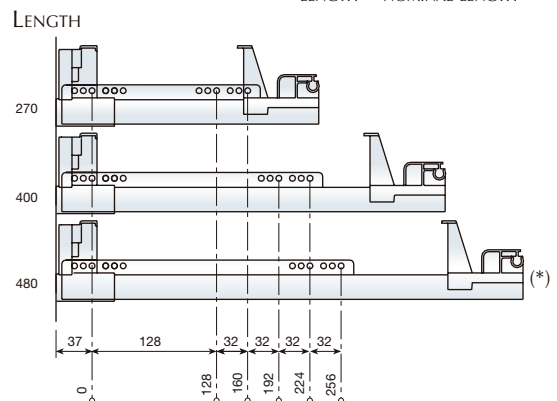

FRONT BRACKET

FRONT BRACKET.

FINISH	REFERENCE	QUANTITY
NATURAL	685.900.106	100

REFERENCE CONSISTS OF 1 COMPLETE SET OF BRACKETS.

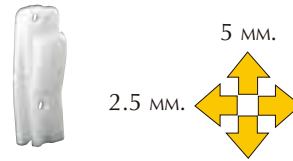

MODULE	F
300	216
350	266
400	316
450	366
500	416
600	516
700	616
800	716
900	816

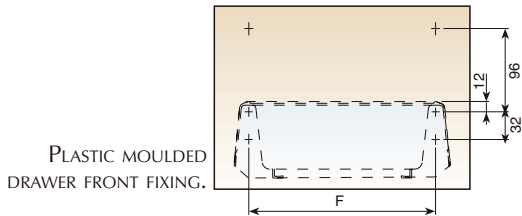

STAINLESS STEEL, EPOXY COATED AND PLASTIC COATED DRAWERS FRONT FIXING.

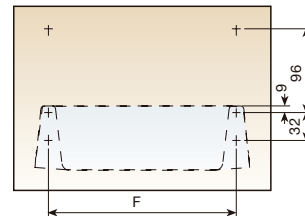

2 ACCESSORIES

POTS & PANS DRAWER ACCESSORIES

CHROME-PLATED PAN DRAWER EXTENDER.

MODULE	REFERENCE	QUANTITY
300	743.330.125	20
350	743.335.121	
400	743.340.124	
450	743.345.120	
500	743.350.123	
600	743.360.122	
700	743.370.121	
800	743.380.120	
900	743.390.126	

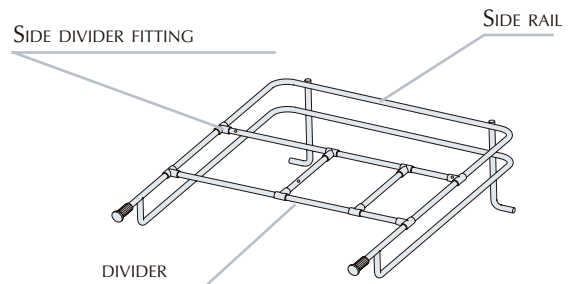

CHROME-PLATED DIVIDER.

MODULE	REFERENCE	QUANTITY
300	745.830.120	50
350	745.835.123	
400	745.840.126	
450	745.845.122	
500	745.850.125	
600	745.860.124	
700	745.870.123	
800	745.880.122	
900	745.890.121	



FIXING DEVICE.

FINISH	REFERENCE	QUANTITY
GREY RAL 7037	732.401.305	100

FRONT BRACKET FOR PAN DRAWER EXTENDER.

FINISH	REFERENCE	QUANTITY
GREY RAL 7037	730.600.301	100

REFERENCE CONSISTS OF 1 COMPLETE SET OF BRACKETS..

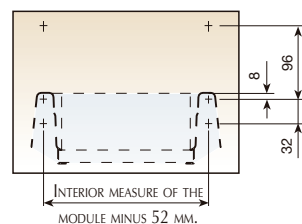

CUTLERY TRAY

PLASTIC CUTLERY TRAY FOR STEEL DRAWERS.

MODULE	WHITE RAL 9001	GREY RAL 7037	WOOD MAPLE-HONEY	
300	687.530.001	687.530.303	687.530.911	
350	687.535.004	687.535.306	687.535.914	
400	687.540.000	687.540.302	687.540.910	20
450	687.545.003	687.545.305	687.545.913	
500	687.550.006	687.550.301	687.550.916	
600	687.560.005	687.560.300	687.560.915	

EVERY REFERENCE COMES WITH ONE SET.



CUTLERY TRAY FOR PLASTIC-MOULDED DRAWER.

MODULE	WHITE	METALLIC GREY	
900	687.590.002	687.590.142	10



SIDE COVER FOR PLASTIC-MOULDED DRAWER

DECOR SIDE COVER FOR PLASTIC DRAWER.

FINISH	REFERENCE	
BRIGHT-ANODIZED	664.548.500	100

REFERENCE CONSISTS OF 1 COMPLETE SET OF DECOR SIDE COVERS.



MAT

MAT FOR STEEL DRAWERS.

MODULE	GREY RAL 7037	
300	443.130.306	
350	443.135.302	
400	443.140.305	
450	443.145.301	20
500	443.150.304	
600	443.160.303	
900	443.190.300	

